

Schottky Rectifier, 2 x 8 A

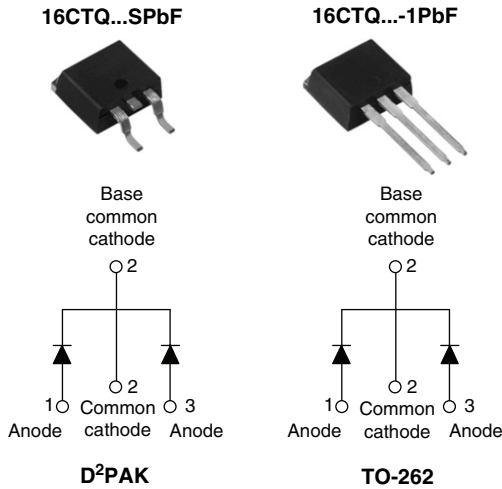

FEATURES

- 175 °C T_J operation
- Center tap configuration
- Low forward voltage drop
- High purity, high temperature epoxy encapsulation for enhanced mechanical strength and moisture resistance
- High frequency operation
- Guard ring for enhanced ruggedness and long term reliability
- Lead (Pb)-free ("PbF" suffix)
- Designed and qualified for Q101 level



Available
RoHS*
COMPLIANT

DESCRIPTION

This center tap Schottky rectifier series has been optimized for low reverse leakage at high temperature. The proprietary barrier technology allows for reliable operation up to 175 °C junction temperature. Typical applications are in switching power supplies, converters, freewheeling diodes, and reverse battery protection.

PRODUCT SUMMARY

| | |
|--------------------|-------------|
| I _{F(AV)} | 2 x 8 A |
| V _R | 60 to 100 V |

MAJOR RATINGS AND CHARACTERISTICS

| SYMBOL | CHARACTERISTICS | VALUES | UNITS |
|--------------------|--|-------------|-------|
| I _{F(AV)} | Rectangular waveform | 16 | A |
| V _{R(RM)} | | 60 to 100 | V |
| I _{F(SM)} | t _p = 5 μs sine | 850 | A |
| V _F | 8 Apk, T _J = 125 °C (per leg) | 0.58 | V |
| T _J | Range | - 55 to 175 | °C |

VOLTAGE RATINGS

| PARAMETER | SYMBOL | 16CTQ060SPbF 16CTQ060-1PbF | 16CTQ080SPbF 16CTQ080-1PbF | 16CTQ100SPbF 16CTQ100-1PbF | UNITS |
|--------------------------------------|--------------------|-------------------------------|-------------------------------|-------------------------------|-------|
| Maximum DC reverse voltage | V _R | 60 | 80 | 100 | V |
| Maximum working peak reverse voltage | V _{R(WM)} | | | | |

ABSOLUTE MAXIMUM RATINGS

| PARAMETER | SYMBOL | TEST CONDITIONS | VALUES | UNITS | |
|---|--------------------|--|--|-------|---|
| Maximum average forward current See fig. 5 | I _{F(AV)} | 50 % duty cycle at T _C = 148 °C, rectangular waveform | per leg | 8 | A |
| | | | per device | 16 | |
| Maximum peak one cycle non-repetitive surge current per leg See fig. 7 | I _{F(SM)} | 5 μs sine or 3 μs rect. pulse | Following any rated load condition and with rated V _{R(RM)} applied | 850 | A |
| | | 10 ms sine or 6 ms rect. pulse | | 275 | |
| Non-repetitive avalanche energy per leg | E _{AS} | T _J = 25 °C, I _{AS} = 0.50 A, L = 60 mH | 7.50 | mJ | |
| Repetitive avalanche current per leg | I _{AR} | Current decaying linearly to zero in 1 μs Frequency limited by T _J maximum V _A = 1.5 x V _R typical | 0.50 | A | |

* Pb containing terminations are not RoHS compliant, exemptions may apply

16CTQ...SPbF/16CTQ...-1PbF Series



Vishay High Power Products Schottky Rectifier, 2 x 8 A

| ELECTRICAL SPECIFICATIONS | | | | | |
|---|----------------|---|-----------------------------------|--------|------------------|
| PARAMETER | SYMBOL | TEST CONDITIONS | | VALUES | UNITS |
| Maximum forward voltage drop per leg See fig. 1 | $V_{FM}^{(1)}$ | 8 A | $T_J = 25\text{ }^\circ\text{C}$ | 0.72 | V |
| | | 16 A | | 0.88 | |
| | | 8 A | $T_J = 125\text{ }^\circ\text{C}$ | 0.58 | |
| | | 16 A | | 0.69 | |
| Maximum reverse leakage current per leg See fig. 2 | $I_{RM}^{(1)}$ | $T_J = 25\text{ }^\circ\text{C}$ | $V_R = \text{Rated } V_R$ | 0.55 | mA |
| | | $T_J = 125\text{ }^\circ\text{C}$ | | 7.0 | |
| Threshold voltage | $V_{F(TO)}$ | $T_J = T_J \text{ maximum}$ | | 0.415 | V |
| Forward slope resistance | r_t | | | 11.07 | m Ω |
| Maximum junction capacitance per leg | C_T | $V_R = 5 V_{DC}$ (test signal range 100 kHz to 1 MHz) 25 $^\circ\text{C}$ | | 500 | pF |
| Typical series inductance per leg | L_S | Measured lead to lead 5 mm from package body | | 8.0 | nH |
| Maximum voltage rate of change | dV/dt | Rated V_R | | 10 000 | V/ μs |

Note

(1) Pulse width < 300 μs , duty cycle < 2 %

| THERMAL - MECHANICAL SPECIFICATIONS | | | | | |
|--|----------------|--------------------------------------|--|-------------|------------------------|
| PARAMETER | SYMBOL | TEST CONDITIONS | | VALUES | UNITS |
| Maximum junction and storage temperature range | T_J, T_{Stg} | | | - 55 to 175 | $^\circ\text{C}$ |
| Maximum thermal resistance, junction to case per leg | R_{thJC} | DC operation | | 3.25 | $^\circ\text{C/W}$ |
| Maximum thermal resistance, junction to case per package | | | | 1.63 | |
| Typical thermal resistance, case to heatsink | R_{thCS} | Mounting surface, smooth and greased | | 0.50 | |
| Approximate weight | | | | 2 | g |
| | | | | 0.07 | oz. |
| Mounting torque | minimum | | | 6 (5) | kgf · cm (lbf · in) |
| | maximum | | | 12 (10) | |
| Marking device | | Case style D ² PAK | | 16CTQ...S | |
| | | Case style TO-262 | | 16CTQ...-1 | |



16CTQ...SPbF/16CTQ...-1PbF Series

Schottky Rectifier, 2 x 8 A Vishay High Power Products

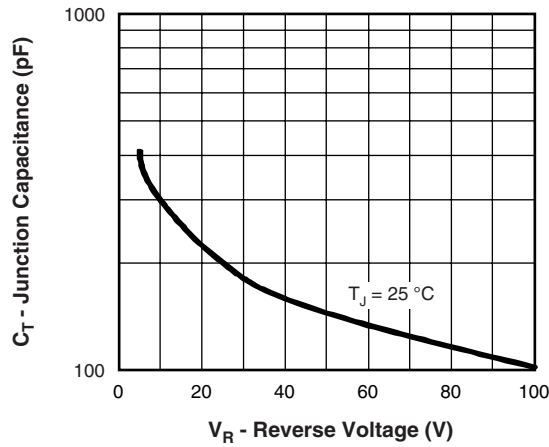
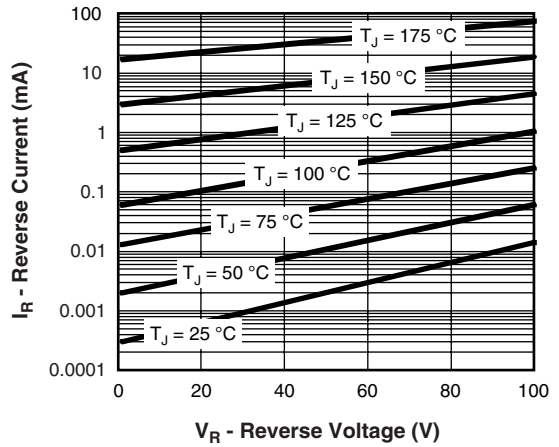
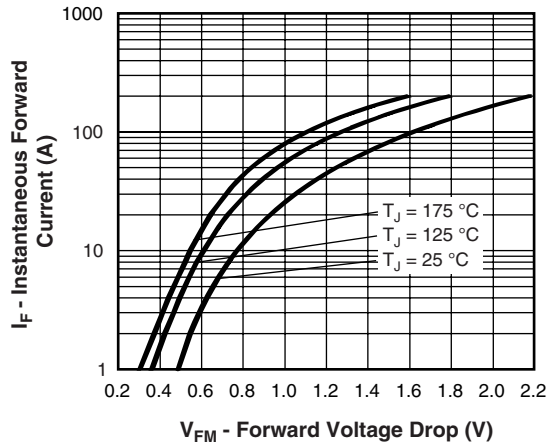

Fig. 3 - Typical Junction Capacitance vs. Reverse Voltage (Per Leg)

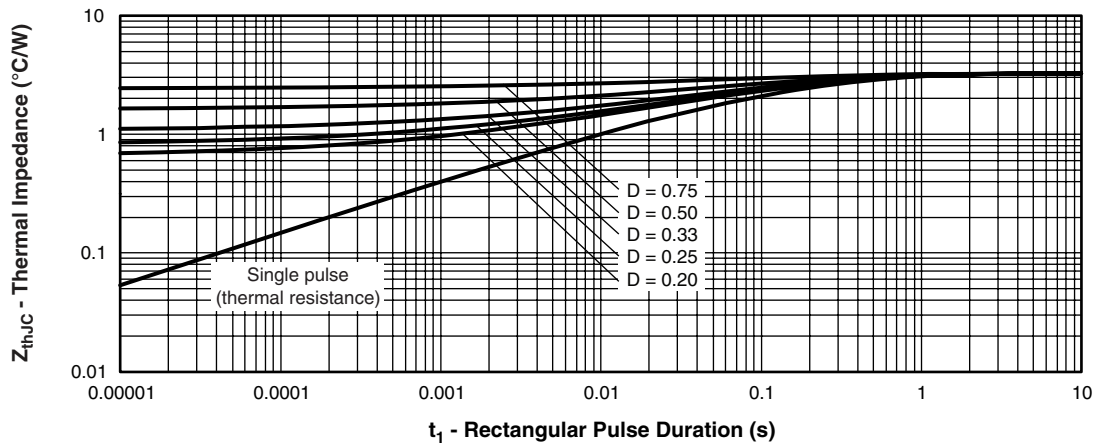

Fig. 4 - Maximum Thermal Impedance Z_{thJC} Characteristics (Per Leg)

16CTQ...SPbF/16CTQ...-1PbF Series

Vishay High Power Products Schottky Rectifier, 2 x 8 A

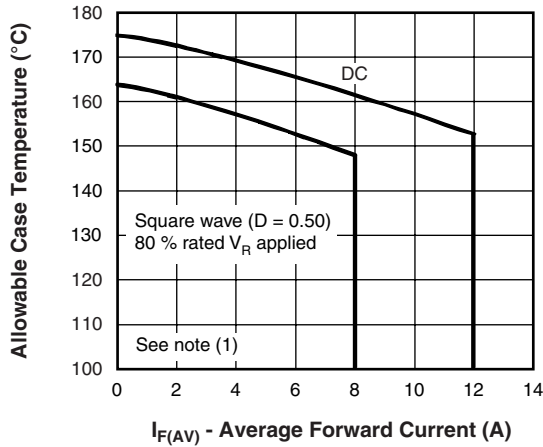

Fig. 5 - Maximum Allowable Case Temperature vs. Average Forward Current (Per Leg)

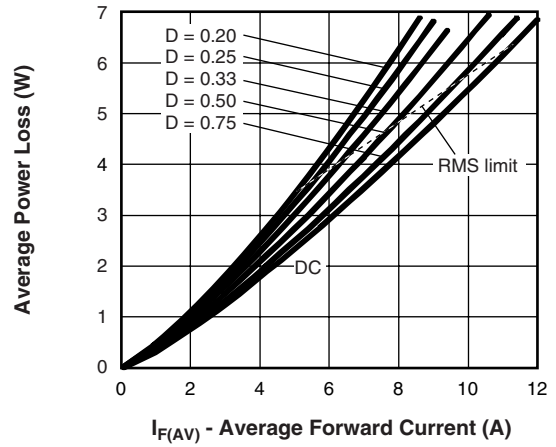

Fig. 6 - Forward Power Loss Characteristics (Per Leg)

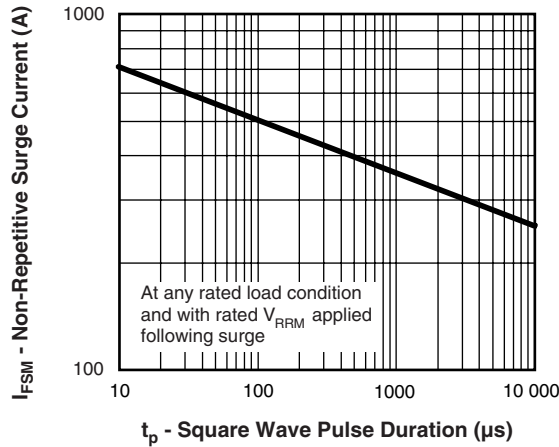

Fig. 7 - Maximum Non-Repetitive Surge Current (Per Leg)



Fig. 8 - Unclamped Inductive Test Circuit

Note

- (1) Formula used: $T_C = T_J - (P_d + P_{d_{REV}}) \times R_{thJC}$;
- P_d = Forward power loss = $I_{F(AV)} \times V_{FM}$ at $(I_{F(AV)}/D)$ (see fig. 6);
- $P_{d_{REV}}$ = Inverse power loss = $V_{R1} \times I_R (1 - D)$; I_R at $V_{R1} = 80\%$ rated V_R applied



16CTQ...SPbF/16CTQ...-1PbF Series

Schottky Rectifier, 2 x 8 A Vishay High Power Products

ORDERING INFORMATION TABLE

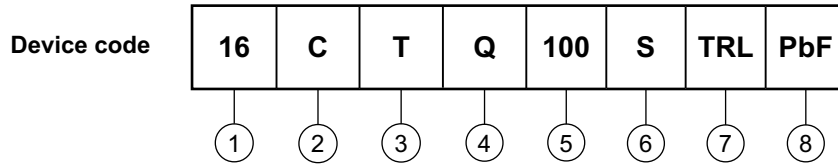

- 1** - Current rating (16 A)
- 2** - Circuit configuration
C = Common cathode
- 3** - T = TO-220
- 4** - Schottky "Q" series
- 5** - Voltage ratings

| |
|-------------|
| 060 = 60 V |
| 080 = 80 V |
| 100 = 100 V |
- 6** -
 - S = D²PAK
 - -1 = TO-262
- 7** -
 - None = Tube (50 pieces)
 - TRL = Tape and reel (left oriented - for D²PAK only)
 - TRR = Tape and reel (right oriented - for D²PAK only)
- 8** -
 - None = Standard production
 - PbF = Lead (Pb)-free

| LINKS TO RELATED DOCUMENTS | |
|----------------------------|---|
| Dimensions | http://www.vishay.com/doc?95014 |
| Part marking information | http://www.vishay.com/doc?95008 |
| Packaging information | http://www.vishay.com/doc?95032 |
| SPICE model | http://www.vishay.com/doc?95279 |



Disclaimer

All product specifications and data are subject to change without notice.

Vishay Intertechnology, Inc., its affiliates, agents, and employees, and all persons acting on its or their behalf (collectively, "Vishay"), disclaim any and all liability for any errors, inaccuracies or incompleteness contained herein or in any other disclosure relating to any product.

Vishay disclaims any and all liability arising out of the use or application of any product described herein or of any information provided herein to the maximum extent permitted by law. The product specifications do not expand or otherwise modify Vishay's terms and conditions of purchase, including but not limited to the warranty expressed therein, which apply to these products.

No license, express or implied, by estoppel or otherwise, to any intellectual property rights is granted by this document or by any conduct of Vishay.

The products shown herein are not designed for use in medical, life-saving, or life-sustaining applications unless otherwise expressly indicated. Customers using or selling Vishay products not expressly indicated for use in such applications do so entirely at their own risk and agree to fully indemnify Vishay for any damages arising or resulting from such use or sale. Please contact authorized Vishay personnel to obtain written terms and conditions regarding products designed for such applications.

Product names and markings noted herein may be trademarks of their respective owners.